

CODE: Power supplies EN54C-LCD series v.1.1/IV
TYPE: Power supplies for fire alarm systems and smoke and heat control systems.

PL

RED POWER plus

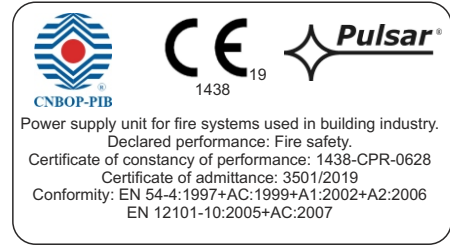

"This product is suitable for the systems designed in compliance with the standards EN 54-4 and EN 12101-10"

Functional requirements	Requirements according to standards	Power supplies EN54C-LCD series
Two independent power sources	YES	YES
EPS network failure indication	YES	YES
Two independent power supply outputs protected against short circuits	YES	YES
Temperature compensation of the battery charging voltage	YES	YES
Measurement of the resistance of the battery circuit	YES	YES
LoB low battery voltage indication	YES	YES
Recharging battery to 80% of rated capacity within 24 hours	YES	YES
Protection against deep battery discharge	YES	YES
Protection against short-circuit at the battery terminals	YES	YES
Charging circuit failure Indication	YES	YES
Short-circuit protection	YES	YES
Overload protection	YES	YES
Output of collective failure ALARM	YES	YES
EPS technical output	YES	YES
Low output voltage indication	-	YES
High output voltage indication	-	YES
Power supply failure indication	-	YES
Protection against surges	-	YES
Input of external failure indication EXTi	-	YES
Tamper switch unwanted enclosure opening	-	YES

PSU features

- Compliant with requirements of EN 54-4:1997+AC:1999+A1:2002+A2:2006 EN 12101-10:2005+AC:2007
- 27,6 V DC uninterruptible power supply
- available versions with **2 A / 3 A / 5 A / 10 A** current efficiencies
- available versions with space for **7 Ah – 65 Ah** batteries
- independently protected outputs AUX1 and AUX2
- high efficiency (up to 89%)
- low level of voltage ripple
- microprocessor-based automation system
- measurement of resistance of battery circuit
- automatic temperature-compensated charging
- automatic battery test
- two-stage battery charging process
- accelerated battery charging
- monitoring of continuity of battery circuit
- monitoring of battery voltage
- monitoring of charging and maintenance of batteries
- deep discharge battery protection (UVP)
- battery overcharge protection
- LoB low battery voltage indication
- battery output protection against short-circuit and reverse connection
- output voltage control
- fuse monitoring of AUX1 and AUX2 outputs
- „SERIAL” communication port with implemented MODBUS RTU protocol and TCP/IP – a list of registers is available
- cooperation with EN54C-LB4 and EN54C-LB8 fuse modules (optional equipment)
- cooperation with EN54C-LS4 and EN54C-LS8 sequential modules (optional equipment)
- relay output of collective failure ALARM
- EPS relay output indicating 230 V power loss
- EXTi input of external failure
- protections:
 - SCP short-circuit protection
 - OLP overload protection
 - OVP overvoltage protection
 - surge protection
 - antisabotage protection – Tamper
- closing enclosure - lock
- convection cooling (forced only in EN54C-10AxxLCD)
- Warranty - 3 years from production date

MOREOVER, IN THE VERSION WITH A LCD AND ETHERNET COMMUNICATION

- optical indication – LCD display
 - display of electrical parameters, e.g. voltage, current, resistance of battery circuit readings
 - failure indication
 - PSU settings adjusted from panel's level
 - adjustable delay for 230 V AC power loss indication
 - 2 levels of password protected access
 - operation memory of PSU
 - failure memory
 - a real-time clock (RTC) with battery backup
- remote monitoring
 - Ethernet communication or RS485 (option)
 - embedded PowerSecurity web application
 - preview of the operating parameters: voltages, currents, temperature and resistance of the battery circuit
 - PSU work history chart from a period of more than 100 days: voltages, currents and resistance of the battery circuit
 - battery operating temperature readings from period up to 5 years
 - event log of up to 2048 power supply failures
 - SSL email encryption
 - remote battery test



General description.

The buffer power supplies has been designed for an uninterrupted supply of fire alarm systems, smoke and heat control systems, fire protection equipment and fire automatics requiring stabilized voltage of 24 V DC ($\pm 15\%$). The power supplies are fitted with two independently protected AUX1 and AUX2 outputs, which provide a voltage of **27,6 V DC** and the total current efficiency depending on the version:

Power supply model	Battery	Continuous operation I _{max a}	Instantaneous operation I _{max b}
EN54C-2A7LCD	7 Ah	1,6 A	2 A
EN54C-2A17LCD	17 Ah	1,2 A	
EN54C-3A7LCD	7 Ah	2,6 A	3 A
EN54C-3A17LCD	17 Ah	2,2 A	
EN54C-3A28LCD	28 Ah	1,8 A	
EN54C-5A7LCD	7 Ah	4,6 A	5 A
EN54C-5A17LCD	17 Ah	4,2 A	
EN54C-5A28LCD	28 Ah	3,8 A	
EN54C-5A40LCD	40 Ah	3,2 A	
EN54C-5A65LCD	65 Ah	2,4 A	
EN54C-10A17LCD	17 Ah	9,2 A	10 A
EN54C-10A28LCD	28 Ah	8,8 A	
EN54C-10A40LCD	40 Ah	8,2 A	
EN54C-10A65LCD	65 Ah	7,4 A	

In case of power loss, the PSU switches to battery power, providing uninterruptible power supply. The power supply unit is housed in a metal enclosure (color red RAL 3001) with space for battery.

Power supply units works with maintenance-free lead acid batteries made with AGM technology or gel technology.



Functional class EN 12101-10:2005+AC:2007	A
Supply voltage	~230 V; 50 Hz
Efficiency	89% max
Output voltage at 20°C	22 V ± 27,6 V DC – buffer operation 20 V ± 27,6 V DC – battery-assisted operation
Maximal resistance of battery circuit	300m Ohm
Ripple voltage	30 ± 150mVp-p max.
Current consumption by PSU during battery-assisted operation	64 ± 97mA
Coefficient of temperature compensation of battery voltage	-36mV/°C (-5°C ± 40°C)
Low battery voltage indication	U _{BAT} < 23V, during battery operation
Over voltage protection (OVP)	U > 32V ± 2V, automatic recovery
Short-circuit protection SCP	F _{AUX1} , F _{AUX2} melting fuse (failure requires fuse replacement)
Overload protection OLP	105-150% of power supply, automatic recovery
Battery circuit protection SCP and reverse polarity connection	F _{BAT} melting fuse (failure requires fuse replacement)
Deep discharge battery protection UVP	U < 20 V (± 2%) – disconnection of the batteries
Tamper indicating enclosure opening	Microswitch TAMPER
Technical outputs: - EPS FLT; output indicating AC power failure - ALARM; indicating collective failure	- relay type: 1 A@ 30 V DC / 50 V AC - delay 10s/1m/10m/30m (+/-5%) – configured from the LCD panel (factory settings 10s) - relay type: 1 A@ 30 V DC / 50 V AC
EXTi technical input	Closed input – no indication Open input - alarm
Optical indication:	- LEDs on PCB of power supply unit - front panel of power supply unit <ul style="list-style-type: none"> • ~230V • AUX • ALARM - LCD panel <ul style="list-style-type: none"> • display of electrical parameters, e.g. voltage, current, resistance of circuit • failure indication • PSU settings adjusted from panel's level • operation memory of PSU – 100 days • failure history - 2048 events • real-time clock, battery-backed
Additional equipment (not included)	- Interface RS485-TTL „INTR-C”; RS485 communication - Interface RS485-Ethernet “INTRE-C”; RS485-Ethernet communication - Interface INTE-C; Ethernet communication - Fuse modules: EN54C-LB4, EN54C-LB8 - Sequential modules: EN54C-LS4, EN54C-LS8
Operating conditions	I environmental class (EN 12101-10:2005+AC:2007), -5°C+40 °C
Enclosure	Steel sheet DC01, 1,0+1,5mm, color RAL3001 (red)
Closing	Key lock
Certification, declarations, warranty	Certificate of constancy of performance CNBOP-PIB No. 1438-CPR-0628, Certificate of approval CNBOP-PIB No. 3501/2019 CE, 3 years from production date
Notes	Enclosure does not adjoin assembly surface so that cables can be led.. convectonal cooling

	PSU power	Charging current	Enclosure dimensions
EN54C-2A7LCD	56,8 W	0,4 A	335 x 308 x 82 [mm]
EN54C-2A17LCD		0,8 A	390 x 406 x 88 [mm]
EN54C-3A7LCD	85,2 W	0,4 A	335 x 308 x 82 [mm]
EN54C-3A17LCD		0,8 A	390 x 406 x 88 [mm]
EN54C-3A28LCD		1,2 A	425 x 411 x 178 [mm]
EN54C-5A7LCD	142 W	0,4 A	335 x 308 x 82 [mm]
EN54C-5A17LCD		0,8 A	390 x 406 x 88 [mm]
EN54C-5A28LCD		1,2 A	425 x 411 x 178 [mm]
EN54C-5A40LCD		1,8 A	425 x 411 x 178 [mm]
EN54C-5A65LCD		2,6 A	416 x 618 x 180 [mm]
EN54C-10A17LCD	284 W	0,8 A	390 x 406 x 88 [mm]
EN54C-10A28LCD		1,2 A	425 x 411 x 178 [mm]
EN54C-10A40LCD		1,8 A	425 x 411 x 178 [mm]
EN54C-10A65LCD		2,6 A	416 x 618 x 180 [mm]

Parameters remote control system.
 (additional modules requiredy)

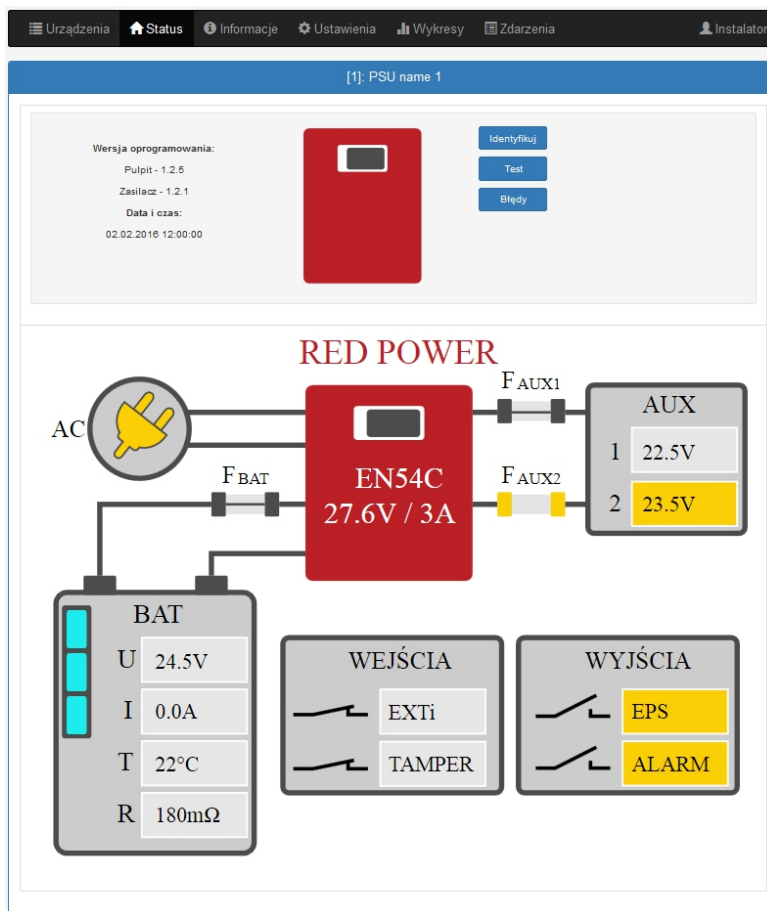
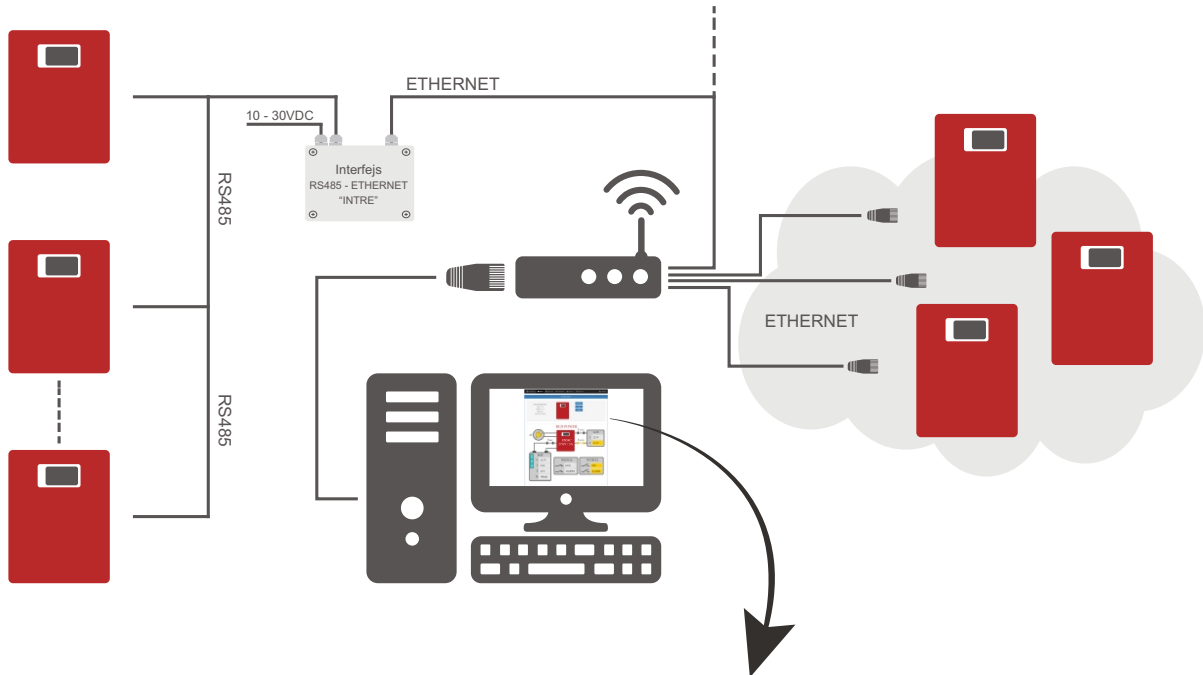

Remote monitoring (options).

PSU has been adjusted to operate in a system that requires a remote control of parameters in a monitoring centre. Implementation of this function is possible upon installation of an additional communication interface. Data are transmitted using the modbus protocol, and their exchange may be effected through a RS485 bus or through the Ethernet.

ETHERNET network communication.

Communication in Ethernet network is possible due to additional Interface: Ethernet „INTE-C” , compliant to IEEE802.3 standard. Ethernet „INTE-C” interface features full galvanic isolation and protection against surges. It should be mounted inside enclosure of PSU. Upon installation, a possibility of connection to the Ethernet is enabled.

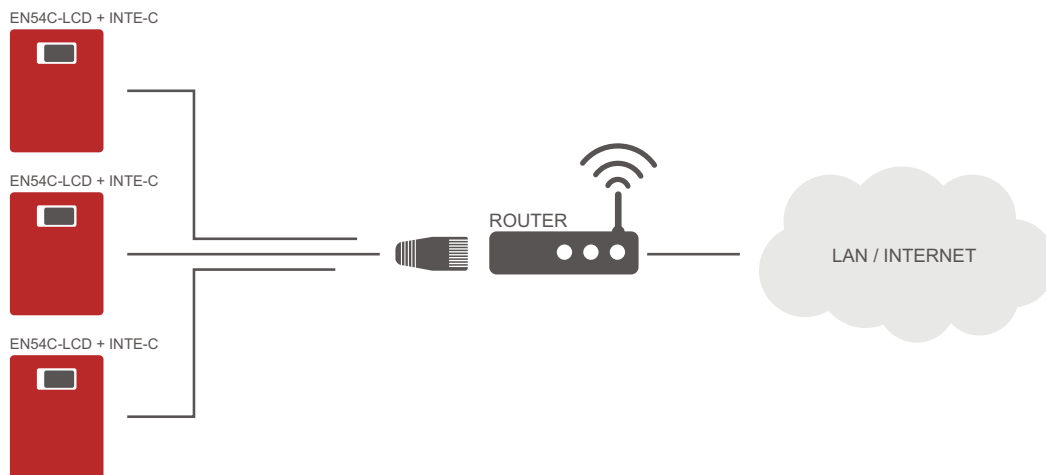

RS485-ETHERNET network communication.

Communication with the PSUs may be effected on the basis of the RS485 bus via additional „INTR-C” and „INTRE-C” modules.

In this kind of communication, an additional RS485-TTL „INTR-C” interface must be installed in each PSU, enabling connection of the PSU to the RS485 bus. A maximum of 247 PSUs may be connected to the bus. Connection with the Ethernet will be enabled by the RS485-ETHERNET „INTRE-C” interface equipped with a RJ45 socket.

RS485-ETHERNET „INTRE-C” interface is a device used to convert signals between RS485 bus and Wi-Fi network. For proper operation, unit requires an external power supply in range of 10÷30 V DC e.g. drawn from a PSU of EN54C-LCD series. Unit is mounted in a hermetic enclosure protecting against adverse environmental conditions.

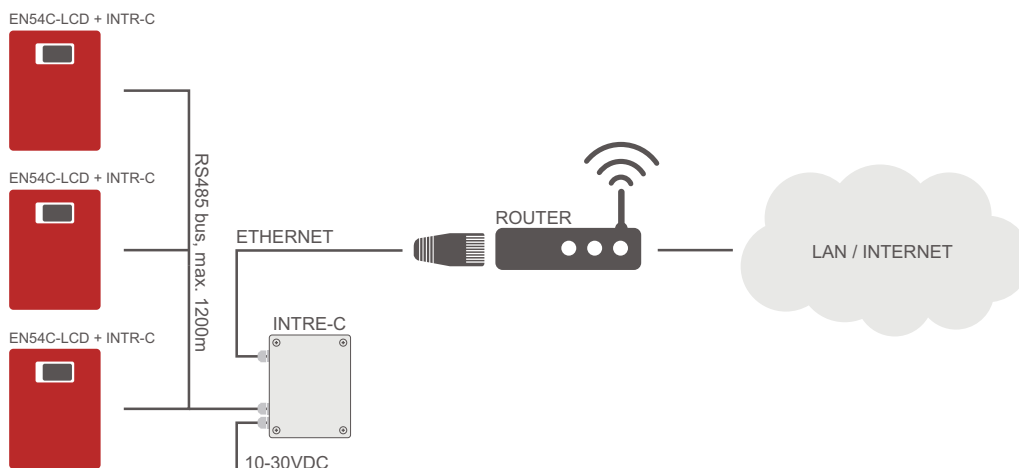

Fuse modules EN54C-LB4 and EN54C-LB8.

Fuse modules EN54C-LB4 and EN54C-LB8 allow to connect 4 or 8 receivers to the PSU. Output state is indicated by green LEDs.

Blown fuse signal is transmitted to the input of collective failure EXTi (ALARM) and saved in the internal memory of PSU.

Relay output of PSU fuse strip can be used for remote control, e.g. external optical indication.

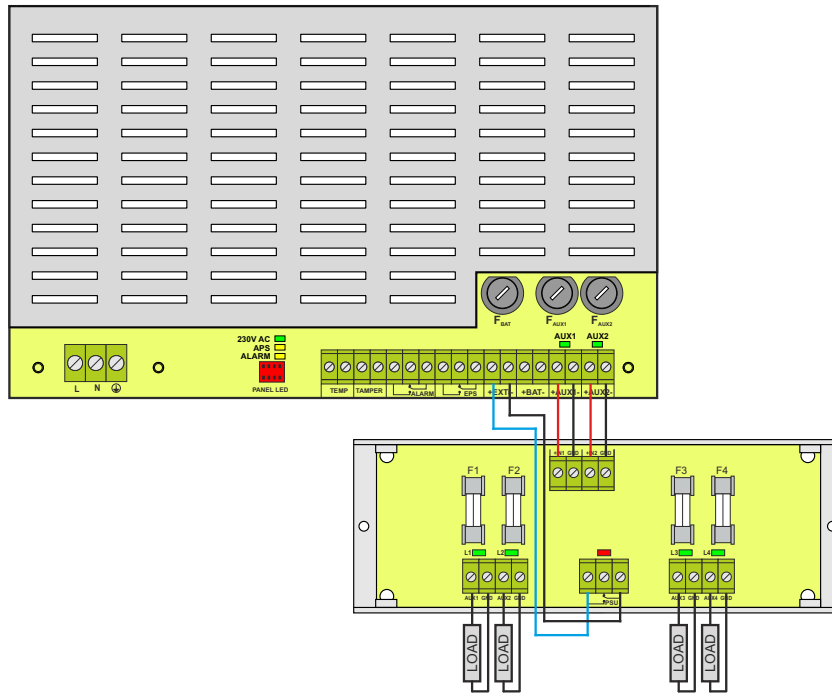

Example of a connection with fuse module EN54C-LB4.

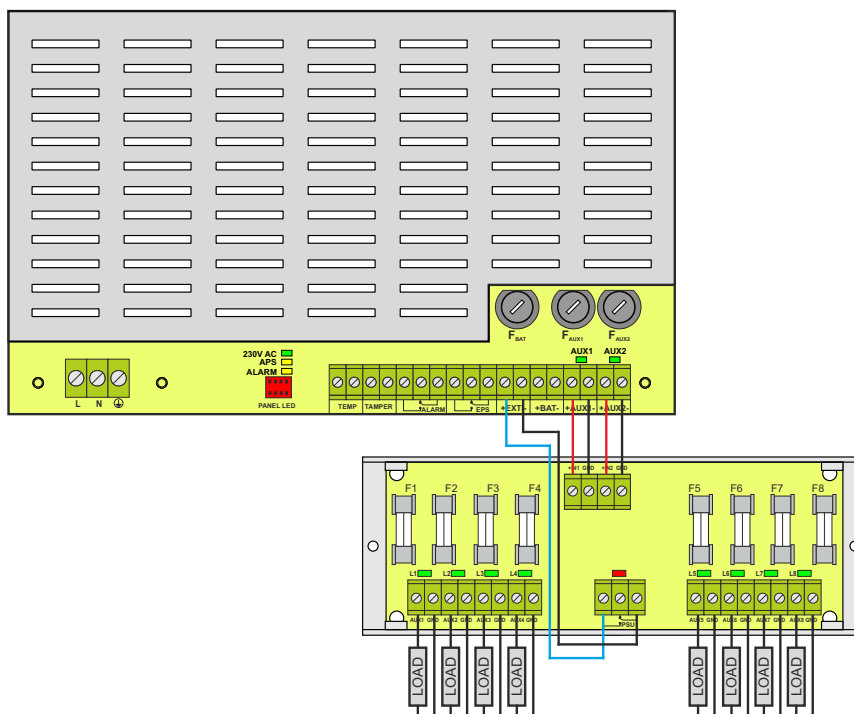

Example of a connection with fuse module EN54C-LB8.

Moduły sekwencyjne EN54C-LS4 oraz EN54C-LS8.

Sequential modules are designed for use with electric actuators without return spring (EN54C-LS4) and with electric actuators with return spring (EN54C-LS8) used for fire dampers and smoke vents. These devices are used in fire alarm systems and smoke and heat control systems. When switching on electric actuator, a short-term current surge, exceeding its rated current, may occur. If multiple electric actuators are connected, above-mentioned surge current poses a risk of incorrect operation of power supply (e.g. triggering protection of output circuit), despite not exceeding current capacity of power supply. Sequential switching module causes receivers connected to its outputs to be sequentially switched, with a delay of 100 ms. Thanks to this solution, surge current is reduced to value ensuring correct operation of power supply.

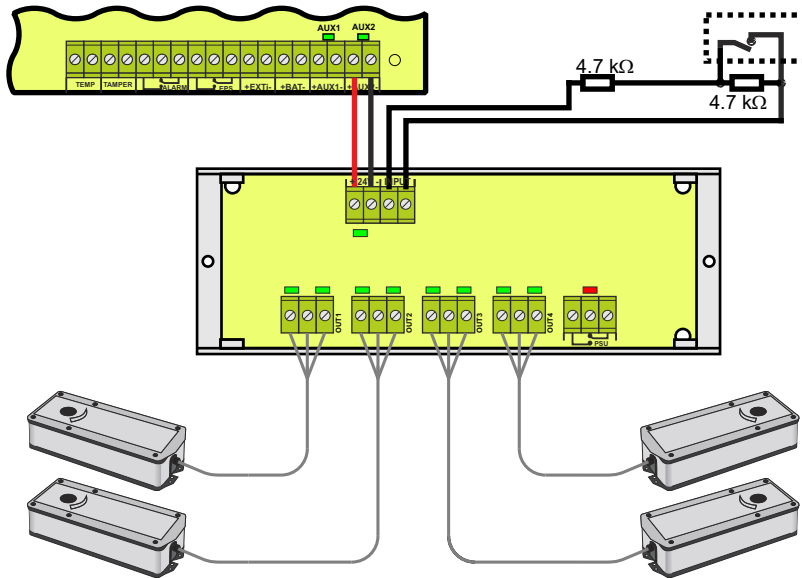

Example of connection of EN54C-LS4 sequential module.

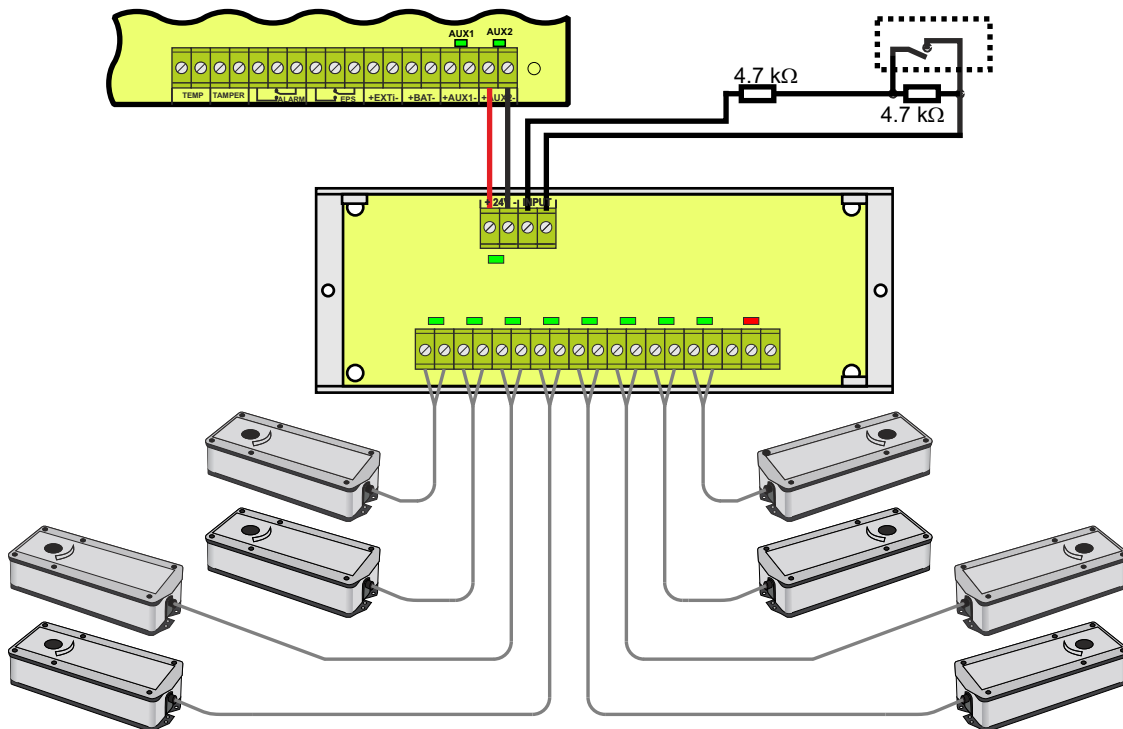

Example of connection of EN54C-LS8 sequential module.